

COVER CLAMP APPLICATIONS

Four tubes, .5" OD
2" x 2" Angle
Clamp, YC2-SS4-500
Bolt, 2.5" long w/nuts
"Facing" Angle acts as cover
Round nut holds bolt in
place during installation.

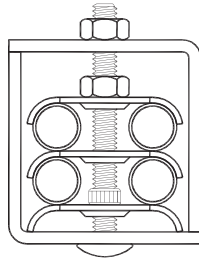

Four fiber optic cables
Clamp, YC4-SS4-250-313
Bolt, .75" long w/nut
Eight tubes, .375" OD
Clamp, YC2-SS4-438
Bolt, 2.5" long
Channel, 4" wide x 2" flange

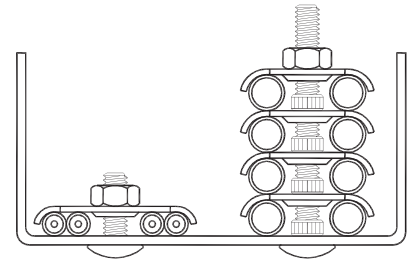

Four small tube bundles
2" x 2" Angle
Clamp, YC2-SS4-500
Bolt, 2.0" long w/nut

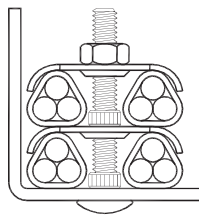

Insulated tube bundle
One bundle, 2.5" OD
Channel, 4" wide x 2" flange
Clamp, BLC1-SS4-2.75
Bolt included with clamp

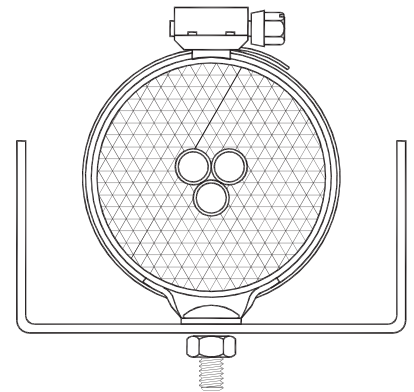

Eight tubes, .5" OD
Channel, 4" wide x 2" flange
Clamp, YC4-SS4-500
Bolt, 1.25" long w/nut
Channel Cover, 4" wide
Channel Cover Clamp

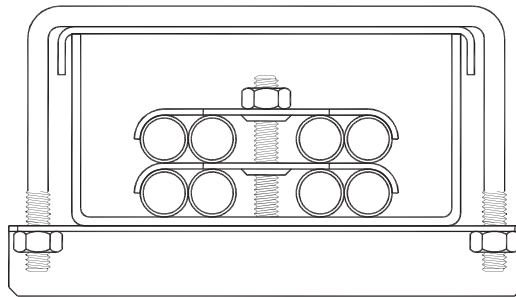

Low-volt control cables
Seven cables, .5" dia.
Channel, 4" wide x 1" flange
Channel Cover, 4" wide
Channel Cover Clamp

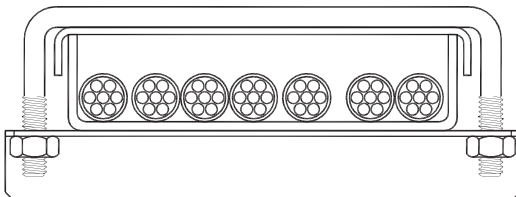

Two fiber optic cables
Channel, 1" wide x 1" flange
Clamp, YC2-SS4-250
Bolt, .75" long w/nut

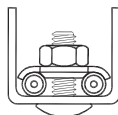



YOKE CLAMP APPLICATIONS

Two tubes, .25" OD
Channel, 1" wide x 1" flange
Clamp, YC2-SS4-250
Bolt, .75" long w/nut

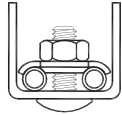

Eight tubes, .375" OD
Channel, 4" wide x 1" flange
Clamp, YC4-SS4-375-1
Bolts, 1.0" long w/nuts

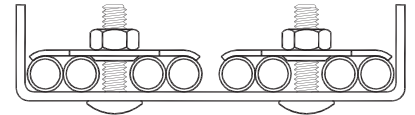

Two fiber optic cables
Channel, 1" wide x 1" flange
Clamp, YC2-SS4-250
Bolt, .75" long w/nut

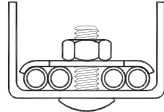

Eight tubes, .375" OD
Channel, 4" wide x 1" flange
Clamp, YC4-SS4-375
Bolts, 1.25" long w/nut

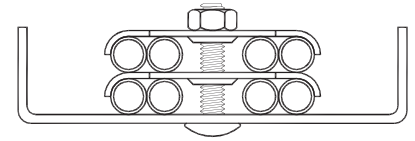

Two tubes, coated .5"
Channel, 2" wide x 1" flange
Clamp, YC2-SS4-500
Bolt, 1.0" long w/nut

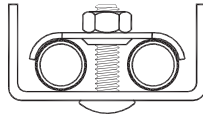

Eight tubes, .375" OD
Channel, 4" wide x 1" flange
Clamp, FC4-SS4-1
Bolt included with clamp

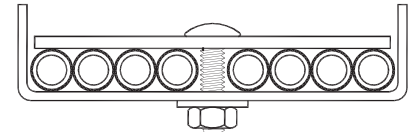

Twelve tubes, .25" OD
Channel, 2" wide x 1" flange
Clamp, YC2-SS4-250-313
Bolt, 1.25" long w/nut

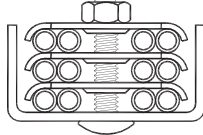

Twenty-four tubes, .25" OD
Channel, 4" wide x 1" flange
Clamp, YC4-SS4-250-313
Bolts, 1.25" long w/nut

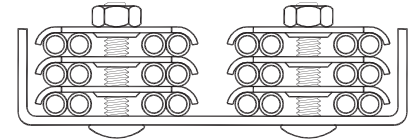

Four tubes, coated .25"
Channel, 4" wide x 1" flange
Clamp, YC4-SS4-250-313
Bolt, .75" long w/nut

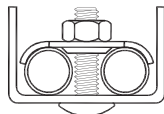

Four tubes, .5" OD
Channel, 4" wide x 1" flange
Clamp, YC4-SS4-500
Bolt, 1" long w/nut

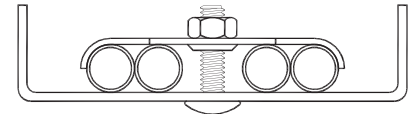

Four tubes, .375" OD
Channel, 2" wide x 1" flange
Clamp, YC4-SS4-375-1
Bolt, 1.0" long w/nut

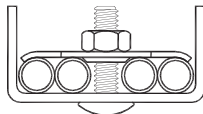

Four coaxial cables
Channel, 2" wide x 1" flange
Clamp, YC4-SS4-375-1
Cover

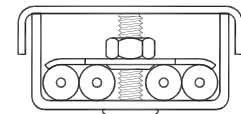

Four tubes, .375" OD
2" x 2" Angle
Clamp, YC2-SS4-375
Bolt, 1.25" long w/nut
Round nut holds bottom layer during installation

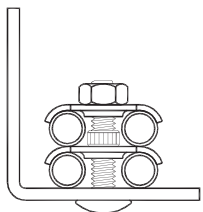

Four tubes, .5" OD
Channel, 4" wide x 2" flange
Clamp, YC2-SS4-500
Spacers SPC2-PL-500
Bolts, 2.0" long w/nut
The spacers raise tubes off deck of channel and allow for tube fittings at any point.

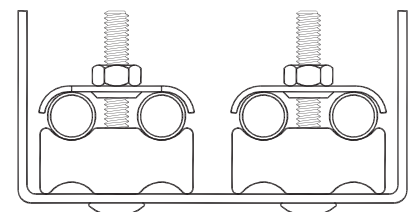

Two tubes, .5" OD
2" x 2" Angle
Clamp, YC2-SS4-500
Bolt, 2.0" long w/nut
Bottom clamp spaces tubes off deck of the angle.

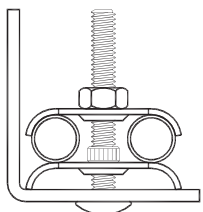

Four pipes, .25" IPS
PVC, Schedule 80 pipes
Channel, 4" wide x 2" flange
Clamp, YC2-SS4-500
Bolts, 2.0" long w/nut
Clamps used to raise pipes off deck of channel for pipe fittings.

